



Semi-mounted ploughs
VARI-MANAGER - CHALLENGER



VARI-MANAGER



CHALLENGER



Table of contents

- 04** A semi-mounted plough with hydraulic variable width for maximum versatility
 - 06** KUHN's solution for high horsepower tractor !
 - 08** High technology design and manufacture
 - 10** The ploughing bodies
 - 12** Spikes and skimmers
 - 14** The wheels
 - 14** A carriage-mounted sowing machine adapted to each farm
 - 15** Specifications
-

VARI-MANAGER | CHALLENGER

Semi-mounted ploughs

THE KUHN PLOUGH

THE FUTURE OF FARMING LIES IN COMPETITIVENESS AND PROFITABILITY.

THE PLOUGH CONCEPT WITH ITS ADVANCED FEATURES WILL CONTRIBUTE TO A QUICK RETURN ON YOUR INVESTMENT. THE KUHN PLOUGH WILL ALLOW YOU TO :



- Maintain a high quality soil structure with an efficient burial of organic matter and an even aggregate spread throughout the soil profile - crop yields will be increased.
- Have at your disposal a wide range of working width settings and an excellent overall manoeuvrability - “in field” costs will be reduced.
- Benefit from a number of technological innovations such as the variable width, the plough structure protection systems (Hydraulic non-stop or traction bolt) - the working life of the plough is increased and maintenance costs reduced.
- Profit from a renowned reliability and long working life allowing you to work throughout the day without interruption - your plough will also keep a high second-hand value.

Opt for a KUHN plough - because obtaining high yields and optimising financial results all starts with high quality ploughing.

A SEMI-MOUNTED PLOUGH WITH HYDRAULIC VARIABLE WIDTH FOR MAXIMUM VERSATILITY

The VARI-MANAGER meets the demands of today' s professionals.

- Robust and durable.
- Total protection of the plough structure with the non-stop hydraulic auto-reset system, shear bolt protected skimmers and transport suspension.
- A high level of versatility for increased work rates, easy adjustments and a hydraulic variable width system for quick and easy adaptation to all working conditions.

A variable width mechanism fully integrated into the plough beam for maximum protection and long life.



Plough turnover

Turnover is carried out by two direct acting horizontal cylinders with no complex mechanical linkages. This very simple turnover system has a minimum of moving parts reducing both the risks of wear and of any possible maintenance requirements. The system comes complete with a hydraulic levelling lock (patented).



One piece headstock

- A quick-hitch cross-shaft is positioned low on the machine for the best possible weight distribution and maximum traction in difficult conditions.
- The cross-shaft features “ U-shaped supports at each end for extra strength.
- The heavy-duty headstock allows the use of tractors up to 240 hp (176 kW).

Hydraulic sequencing (patented)

In the tractor cab the same lever controls both the lifting out of work and turnover of the plough in one combined automatic operation greatly simplifying headland manoeuvres and reducing driver fatigue.

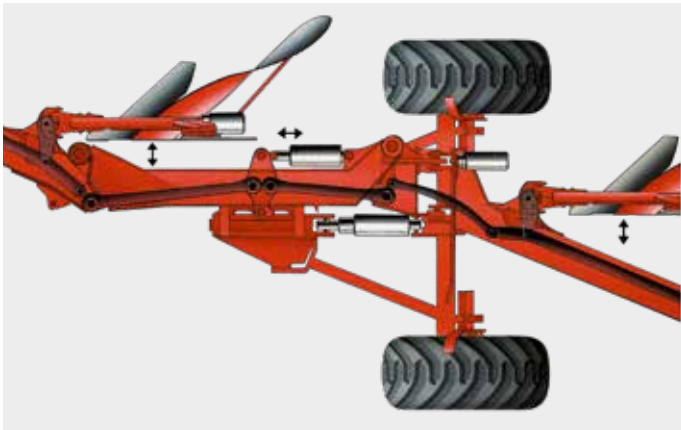

All moving parts fully integrated into the plough beam

The whole linkage mechanism responsible for the variable width changes is housed inside the plough beam. All links and moving joints are in this way fully protected from abrasive agents (dust, corrosion) as well as from any possible impact damage.

- This exclusive KUHN feature ensures a long trouble free working life.
- All variable width linkages and articulation points are heavy duty for an exceptionally strong overall construction.
- All moving joints are fitted with heavy duty bushes.

Advantages of the variable width system

- To adapt quickly to available traction.
- To adapt to different soil types, ground relief and field size whilst maintaining a high work rate.
- To alternate the plough profile summer and winter.
- To cope with large amounts of trash.
- To neatly finish up to the field border.
- To avoid obstacles and tidy the furrow.



CHALLENGER

KUHN'S SOLUTION FOR HIGH HORSEPOWER TRACTOR !

The CHALLENGER range is without doubt the plough for high horsepower tractors and extremely difficult working conditions. Its number of bodies ensure that the highest work rates are achieved.

The CHALLENGER's 220 mm section beam ensures robustness during work and combined with its safety system (traction bolt or Non Stop Security) a long life. The beam's articulation and the plough's transport suspension gives you a more sensitive reaction to ground and road conditions during use.



CHALLENGER 12 T on-land

Large offsetting adjustment

Large adjustments can be made to the plough offsetting (its angle in relation to the tractor) from the tractor seat by simple action on one of the spool levers. This allows for easy adaptation to all possible tractor inter-wheel distances and also permits a complete cancellation of the effect of the first body for particular circumstances e.g. finishing a field, going round obstacles etc.



Multiple working widths 14", 16" and 18"

Whether a traction bolt model or non-stop hydraulic (NSH), changes in working width to settings of either 14", 16" or 18" are quick and easy to carry out. The width fixing bolt is removed and the plough leg pivoted to the desired width setting. The rear beam angle is changed in the same manner and shims at the articulation joint moved to positions corresponding to the required width setting.



Ploughing on-land

- Greater distribution of weight load reducing compaction to a minimum
- No tractor wheel slip in the furrow
- Reduced tyre wear on stony ground
- Extra wide tyres or dual wheels can be used
- Time savings - not necessary to disassemble dual wheels for ploughing.

The CHALLENGER in its "on-land" version can be easily transformed back to an "in the furrow" plough when wet conditions reduce traction on land. A front mounted depth wheel is essential when working in the on-land position.

HIGH TECHNOLOGY DESIGN AND MANUFACTURE



PATENTED

Hydraulic beam articulation (patented)

Fitted as standard the hydraulic articulation allows an adjustment (from the tractor cab) of the amount of articulation travel according to soil conditions.

A hydraulic accumulator integrated into the hydraulic circuit has the advantage of giving a more sensitive reaction to small ground level changes.

Transport suspension

- Fitted as standard on the CHALLENGER, optional on the VARI-MANAGER.
- Transport safety is maximised with 3 weight bearing points (two carriage wheels and tractor arms) giving an improved overall balance to the plough in the transport position.
- There are no protruding depth wheels when on the road.
- Suspension in the transport position is provided by means of an undercarriage mounted shock absorber protecting the entire length of the plough from possible transport shocks.

T-safety

Tensile breakage at a share point load of 4,700 kg avoids too frequent stresses on the safety device.

- No shearing effect as the bolt is only loaded in tension.
- No ovality of the support nut.
- No jamming of the Ø 16 mm bolt after breakage, it is very easy to replace.
- The ploughing depth is maintained despite the triggering of the T safety device.





NSH safety

The general design of non-stop safety systems allows for an increasing or decreasing release curve upon encountering the obstacle.

As the body is lifted, the resistance to the tip increases, giving it more energy to return to the ground.

The integration of all the elements increases the flow channel of the soil and residues.

Exceptional clearances : + 70 cm vertically and 20 cm laterally, on both sides ; the highest values on the market.

Weight saving : - 25 kg / ploughing body compared to a mechanical non stop.

- **VARIBAR option** : allows the pressure at the share tip to be varied from the tractor while ploughing; immediate adaptation to working conditions.
- **MAXIBAR option** : instantaneous overtrimming (600 to 2500 kg) of the safety devices to work on very heavy soils.

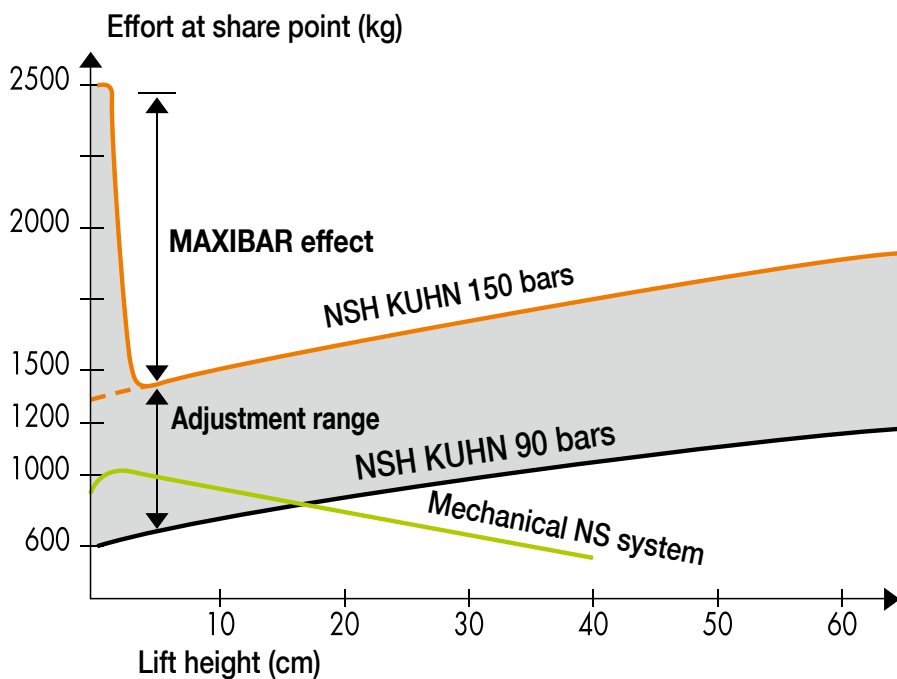

Highly resistant toggle and tie-rod mechanism

- All holder surfaces undergo specific heat-treatment.
- 1 single pivot point and direct transmission of forces down the plough leg via a one-piece forged and treated tie-rod.

THE PLOUGHING BODIES

The experience acquired by KUHN in the world of ploughing for almost 120 years has enabled the development of a range of plough bodies adapted to all the needs of farmers. Made from noble and robust materials, KUHN plough bodies are designed to guarantee optimal penetration in all soil conditions with maximum life span.



		T	L	HC	HB Plastique	RM	N	C	P	RB	V	VL	YL
		Helical body	Helical wide	Helical scandinavian	Helical scandinavian	Helical- cylindrical	Helical- cylindrical	Short cylindrical	Long cylindrical	Cylindrical wide	Cylindrical slatted	Wide helical slatted	American blade
Features	Working depth	12 to 25 cm	20 to 35 cm	15 to 30 cm	15 to 30 cm	15 to 30 cm	15 to 30 cm	20 to 35 cm	20 to 35 cm	20 to 35 cm	20 to 30 cm	15 to 25 cm	12 to 25 cm
	Dimension	430x490x1400	430x490x1220	390x400x1250	390x400x1250	380x400x1000	380x395x990	380x395x990	380x380x1095	460x470x1250	460x470x1250	460x470x1250	340x400x865
	Bow type					Curved (Opt)							
Working conditions	Light soil (sand)	++	+	+	+	o	+	o	o	o	o	+	++
	Medium soil	++	++	++	++	+	++	+	+	+	++	+	+
	Heavy soil	o	+	+	+	++	++	++	++	++	++	+	o
	Light and sticky conditions	+	o	+	++	o	o	o	o	o	++	+	+
	Heavy and sticky conditions	o	+	++	++	o	o	+	++	++	++	+	o
Ploughing type	Stony conditions	++	++	++	x	++	++	++	++	++	o	o	++
	Sloping ground	++	++	+	+	+	+	o	o	o	o	+	o
	Crumbling	+	+	+	o	++	+	++	++	o	++	++	+
	Furrow bottom clearance	++	++	+	+	++	o	o	o	+	o	++	o
	Low traction requirement	+	o	+	+	++	++	++	++	+	++	+	++
Turning capacity	++	++	++	++	+	+	+	+	+	++	+	++	
Working speed (kph)	6 - 10	6 - 10	6 - 8	6 - 8	6 - 8	6 - 8	6 - 8	4 - 6	4 - 6	6 - 8	4 - 6	6 - 10	6 - 8





3,3 mm hard
Working surface

2,3 mm flexible
Moldboard elasticity

1,5 mm hard
Moldboard structure

Increase the life of your mouldboards by 40%

TRIPLEX mouldboards have uneven layers with more thickness in the working area and a softer layer in the middle to ensure the best compromise between wear resistance and ploughing quality.

Your KUHN plough equipped with TRIPLEX mouldboards gives you one of the lowest wear costs per hectare on the market.

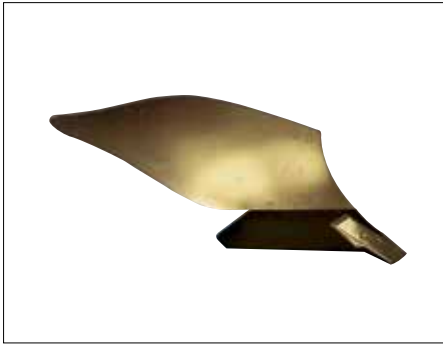

L Helical

Multi-purpose mouldboard for set-up furrows or reversible ploughing according to work speed. Wide clearance of the furrow bottom for passage of large tyres.

- Working depth between 18 to 35cm
- Tyre width : 710mm

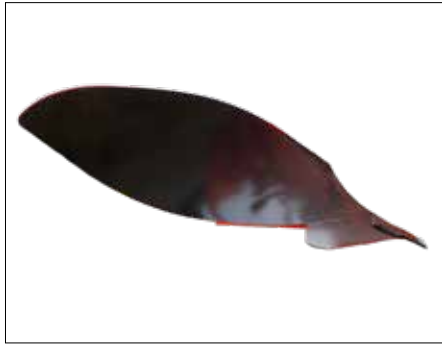

T Helical

New generation high capacity, long helical mouldboard Scandinavian type, giving well formed ploughing. Especially suited to a wide variety of soils. Wide clearance of the furrow bottom for passage of large tyres.

- Working depth between 12 to 28cm
- Tyre width : 710mm



N Helical Cylindrical

Versatile mouldboard. Cylindrical at front part and helical at the rear part.

- Working depth between 15 to 30cm
- Tyre width : 650mm



HC Helical

HC Body. High capacity, long helicoidal mouldboard, Scandinavian type, giving well formed ploughing to a depth of 30cm. Especially suited to heavy and damp clays. (also available in plastic)

- Working depth between 15 and 30cm
- Tyre width : 650mm



P Cylindrical

Spring soil preparation with good surface crumbling for immediate seeding. High-speed capacity.

- Working depth between 20 and 35cm
- Tyre width : 650mm

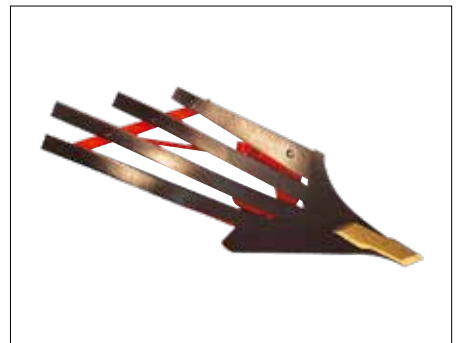

V Slatted Body

Mouldboard composed of independant and interchangeable slats. Give a reduction of traction force, due to a lower mouldboard surface area. Easy maintenance.

- Working depth between 20 and 30cm
- Tyre width : 650mm

SPIKES AND SKIMMERS

6 reasons to choose KUHN forged wear parts

- 1. The type of steel :** offers the best compromise between hardness (wear resistance) and resilience (impact resistance).
- 2. Heat treatment :** prevents breakage and increases the parts' robustness.
- 3. Ease of assembly :** the forging process allows for consistent and uniform production with precise tolerances and a longer service life.
- 4. The distribution of the material :** we concentrate the material in the areas where it counts most to make sure you get a longer service life out of the parts.
- 5. + 20% compared to standard parts :** KUHN forged parts have a 20% longer service life than standard parts.
- 6. A well-developed distribution network :** optimal availability and short delivery times. You're guaranteed minimum downtime and optimised production costs.



MARATHON

Special heat treated forged steel. Reversible for maximum efficiency. Featuring a step giving better landside protection.



EXCLUSIVE

OLYMPIC

A reworked tip for a better soil penetration. This point, whose thickness has been reinforced in the most exposed areas, offers a lifespan of more than 30% compared with the previous generation.



EXCLUSIVE

DURAKARB

The DURAKARB carbide plow share features angular carbide plates. This new point will be your perfect ally for controlled and long-lasting ploughing, without requiring any extra power. Service life x4 vs an OLYMPIC point.

The role of the skimmer is essential since it allows to cut the strip of soil to bury the organic manure in the bottom of the furrow before the passage of the body.



VERSATILE SKIMMER ZX



MAIZE SKIMMER ZRL



LARGE CAPACITY SKIMMER ZGC

		Versatile skimmer ZX	Maize skimmer ZRL	Large capacity skimmer ZGC	Helical skimmer ZHL	Deflector DF
Working conditions	Living plant residues rooted and shredded	+	+	+	++	o
	Living plant residues rooted and not shredded	+	+	++	++	+
	Meadow	o	o	+	++	o
	Stubble with shredded straw	++	++	++	+	+
	Stubble with straw removed	++	+	+	++	o
	Non shredded large residues	o	++	+	+	+
Working quality	Distribution of residues over the entire ploughing profile	+	+	+	+	++
	Intermediate ploughing (residues scattered on the surface)	++	++	++	+	+
	Deep ploughing (with no residues on the surface)	++	+	+	++	o
Working speed (kph)		6 - 10	6 - 10	6 - 8	6 - 10	6 - 8

Nearly adapted Adapted Perfect



HELICAL SKIMMER ZHL



DEFLECTOR DF

Independent shavers with total safety

Sleeve mounting : permanent hold of the shaver, no risk of sliding or rotating around the shaft.

Simple and precise adjustment:

- 1. Longitudinal :** 3 positions to locate the burial.
- 2. Height :** by adjustment holes with anti-loss pin.
- 3. Lateral :** for a perfect adaptation to circular coulters.

Security by bolt ensuring a clean break at 1800 kg at the share tip.

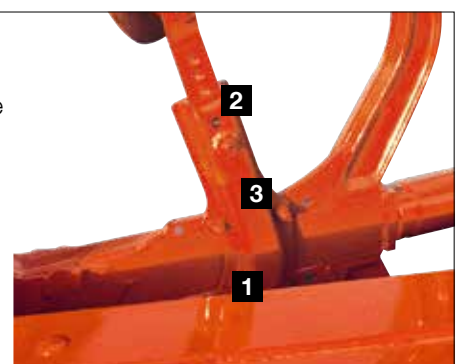

THE WHEELS



Modular construction

Each plough is made up of three basic elements : 1 front beam, 1 rear beam and the extension/s. Following the assembly specifications set out in the table below the plough can be built up by yourself to correspond to the available tractor power.



Rear depth control wheel

Fitted with a 600 mm (VARI-MANAGER range) or 690 mm (CHALLENGER range) tyre, the rear beam mounted depth wheel pivots freely from side to side to follow all changes in working width. The wheel is simply designed and easy to adjust : depth adjustments by turning handle screw **C** with the possibility to set the depth independently left from right.



Depth wheel with shock absorber

Available for the CHALLENGER series in 690 mm diameter with rubber tyre. The shock absorber not only removes the shock of the wheel falling during turnover but also ensures the wheel is in the correct rearwards inclined position as the plough is lowered back into work.

A CARRIAGE-MOUNTED SOWING MACHINE ADAPTED TO EACH FARM

VARI-MANAGER

Suitable for tractors from 149 to 239 hp. (110 to 176 kW)



CHALLENGER

Suitable for tractors from 287 to 492 hp. (210 to 360 kW)



Specifications

	Number of bodies	Beam configuration	Max authorized tractor power (kW/hp)	Weight (kg)	Safety	Working width (inches/cm)	Under beam	Point to point
VARI-MANAGER	5	3+2	110/149	3150	NSH auto-reset	12" to 20" 30 to 50	80	102
	6	3+(2+1)	132/179	3500				
	7	(3+1)+(2+1)	154/209	3850				
	8	(3+1+1)+(2+1)	176/239	4200				
CHALLENGER T	7	4+3	210/287	3760	Traction bolt	14", 16" and 18" 35, 40 and 45	80	102
	8	(4+1)+3	240/322	4048				
	9	(4+1)+(3+1)	270/369	4336				
	10	(4+1+1)+(3+1)	300/410	4624				
	11	(4+4)+3	330/451	4912				
	12	(4+4)	360/492	5200				
CHALLENGER NSH	7	4+3	210/287	4110	NSH auto-reset	14", 16" and 18" 35, 40 and 45	80	102
	8	(4+1)+3	240/322	4428				
	9	(4+1)+(3+1)	270/369	4746				
	10	(4+1+1)+(3+1)	300/410	5064				
	11	(4+4)+3	330/451	5382				
	12	(4+4)+(3+1)	360/492	5700				



KUHN PARTS



Designed and manufactured to rival time. KUHN foundries and forge as well as a high-level manufacturing process allow the production of spare parts to defy time. You can truly rely on our know-how and our genuine parts. Farmers benefit from our client support and logistics services via any KUHN PARTS warehouse, which provide quick and reliable repair solutions in cooperation with your nearest authorized KUHN dealer.



KUHN SERVICES*

KUHN sos order - Express spare parts service, 24/7**
KUHN protect+ - The choice of professionals!
KUHN i tech - For ever quicker repairs!
KUHN finance - Invest rationally!

* Not all services are available in all countries. ** except January 1, May 1 and December 25

MyKUHN

MY CONNECTION TO SUCCESS !

MyKUHN is your on-line customer space. Sign up now and discover how the exclusive services offered by MyKUHN will facilitate the management of your fleet of KUHN machines and terminals as well as help you maximize their performance. Once identified, on computer, smartphone or tablet, you will have access to parts catalogs, technical documentation and numerous connected services.



Discover the KUHN semi-mounted plough ranges

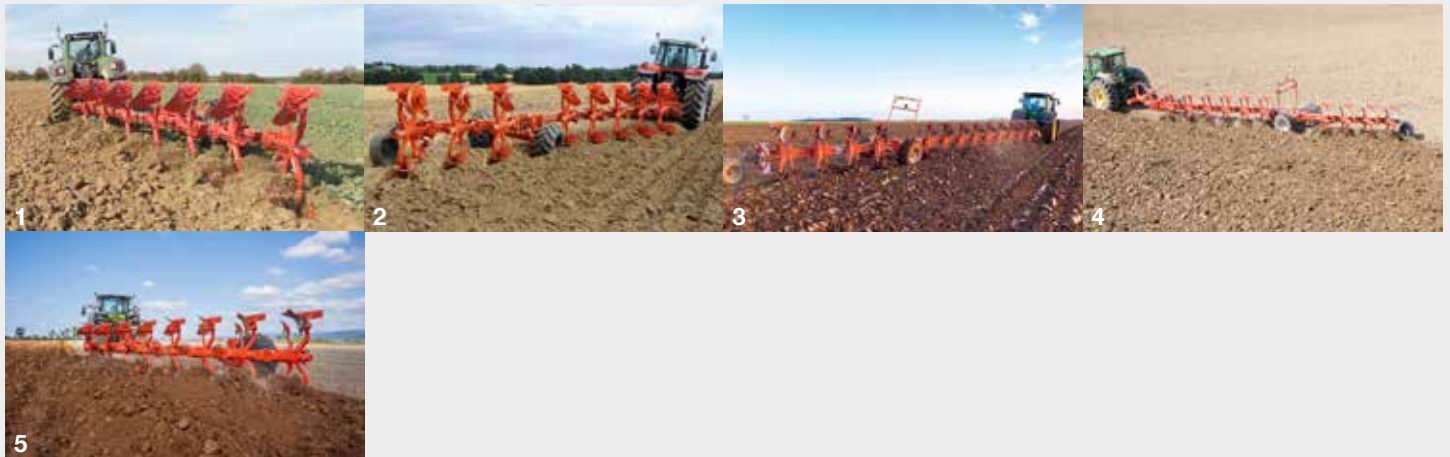

1. VARI-LEADER - 2. VARI-MANAGER - 3. CHALLENGER - 4. VARI-CHALLENGER - 5. MULTI-LEADER XT

KUHN-HUARD SAS - Zone Horizon - 2, Rue de Québec - F-44110 CHATEAUBRIANT - France

To find your nearest KUHN dealer,
visit our website www.kuhn.com

Information given in this document is only for information purposes and is non-contractual. Our machines are in compliance with regulations in force in the country of delivery. In our literature, and for improved illustration of certain details, some safety devices may not be in operating position. When operating these machines, these devices **must** be in position in accordance with the requirements indicated in the operator's manuals and pre-delivery instructions. RESPECT THE ROAD REGULATIONS IN FORCE AS WELL AS the tractor gross vehicle weight rating, its lift capacity and maximum load per axle and tyres. The tractor front AXLE load must always comply with the regulations of the country of delivery (In Europe, it must reach minimum 20 % of the tractor net weight). We reserve the right to change any designs, specifications or materials listed without further notice. Machines and equipment in this document can be covered by at least one patent and/or registered design. Trademarks cited in this document may be registered in one or several countries.

To protect the environment, this leaflet is printed on chlorine-free paper.
Printed in France - 950 034 EN - 03.24 - Copyright 2024 KUHN

